



Ürün Kodu Product Code	DP4 SAR1K3
---------------------------	------------

Araç Tipi Vehicle Type	MERCEDES							
---------------------------	----------	--	--	--	--	--	--	--

Şanzıman Tipi Gearbox Type	G125-16	G135-16	G155-16	G180-16	G200-16	G210-16	G210-16	G240-16
	G240	G260-16	G231-16	G255	G211-16	G330-16	G1319	G2811
	G241	G281	G2219					

Montaj Şekli Mounting Side	Kontrol Tipi Control Type	Dönüş Yönü Rotation Sense	Çevrim Oranı Ratio	Ağırlık Weight	Güç Power	Maksimum Tork Maximum Torque	
				Kg	KW	Nm	Kgm
KUYRUK REAR	HAVALI PNEUMATIC	SAĞ (SAAT YÖNÜ) RIGHT (CLOCKWISE)	1/1	2,5	50	490	50

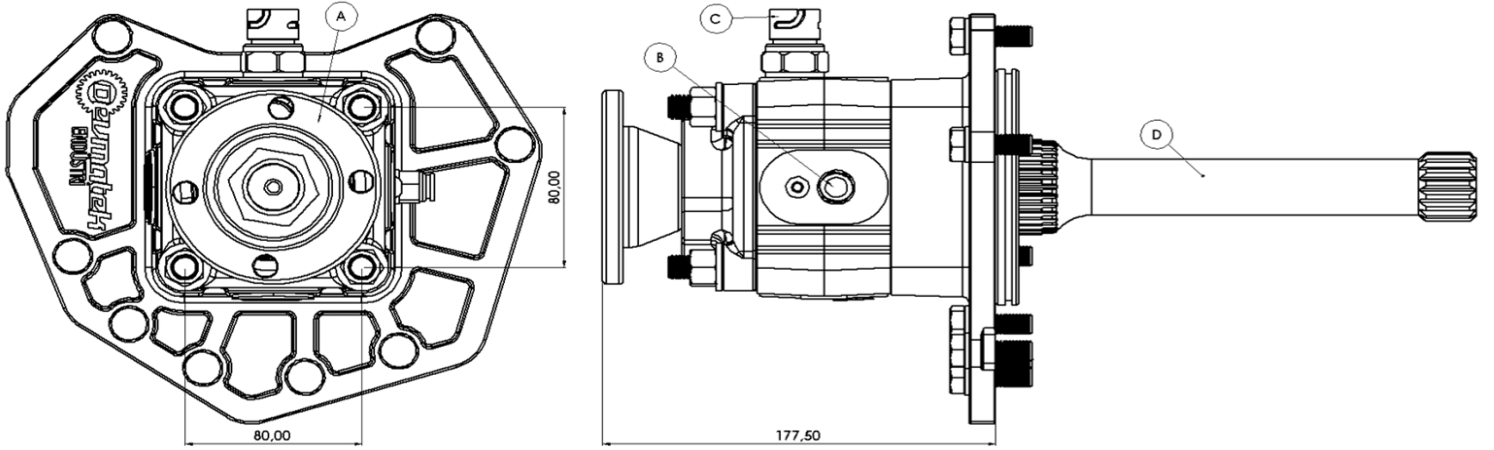

PTO ÖZELLİKLERİ PTO PROPERTIES	A		B		C		D	
	PTO Çıkış PTO Output	PTO Output	Hava Girişi Air Intel	Air Intel	Elektrik Müşürü Electrical Swithc	Electrical Swithc	Kardan Mil Cardan Shaft	Cardan Shaft
	4 Delik Flanş 4 Hole Flange		R 1/4"		12V		L=250 mm	
			R 1/4"		12V		L=267 mm	
							L=275 mm	
							L=291 mm	

Phone : +90 212 647 7700

Email : info@devmatek.com

Address : Ömerli Mah. Mısır Sk. No:5 Arnavutköy/İstanbul

Mobile : +90 552 670 6056

Web : www.devmatek.com

